

**AIR CURTAIN
INSTALLATION MANUAL**

Air supply

**Premium plus
Series**

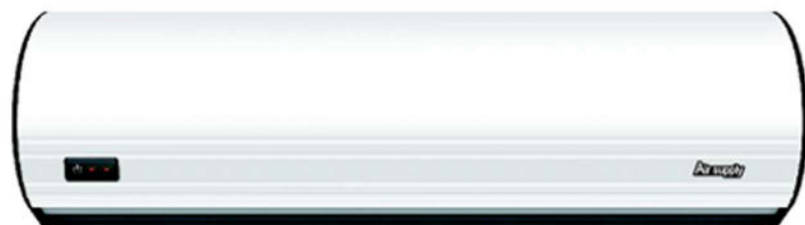

**Thanks for purchasing this Air Curtain,
please read these instructions carefully before use.**

1、 IDENTIFICATION & INSTALLATION DIMENSIONS

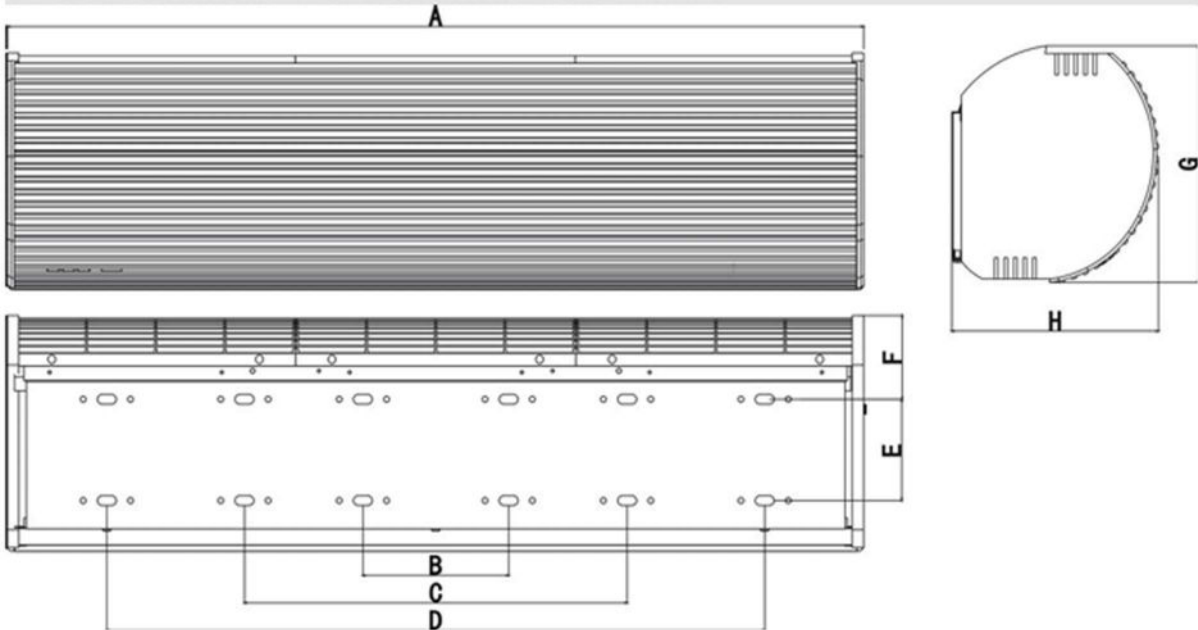

MODEL	A	B	C	D	E	F	G	H
Premium plus 90cm	900	---	695	---	100	85	240	220
Premium plus 90cm BLK		---	695	---				
Premium plus 100cm	1000	---	695	---				
Premium plus 100cm BLK		---	695	---				
Premium plus 120cm	1200	295	990	---				
Premium plus 120cm BLK				---				
Premium plus 150cm	1500	504	1285	---				
Premium plus 150cm BLK				---				
Premium plus 180cm	1800	210	885	1580				
Premium plus 180cm BLK				1580				
Premium plus 200cm	2000	210	885	1580				
Premium plus 200cm BLK				1580				

2、 INSTALLATION CAUTION

Must follow the following asking when installing air curtain :

2.1 Please install the unit in a sturdy place to avoid the shaking and ensure its security (because it maybe cause the wall becoming flexible or shaking and noise.

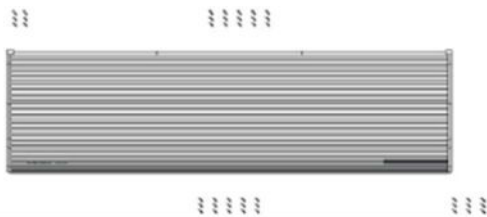

2.2 Please install the unit inside the room.

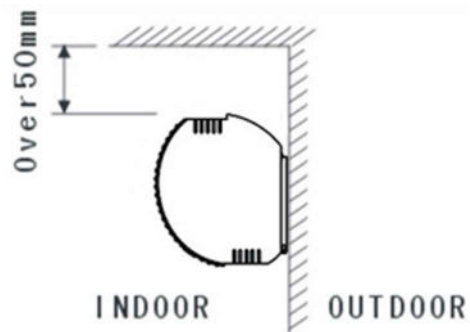

2.3 Don't install the unit too low, no less than 2.3 meter from the ground.

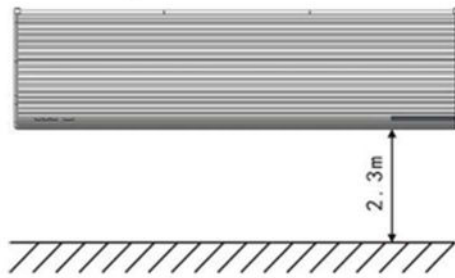

2.4 When the entrance is wider than the unit, it is recommended to install two or more units in parallel. In this case, provide 20-40mm gaps between the units.

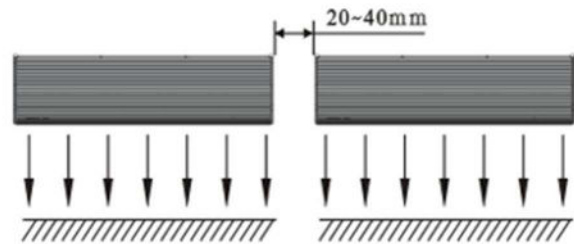

2.5 Don't allow gaps between the unit and the wall. When hanging it from the ceiling, using the enclosed ceiling brackets.

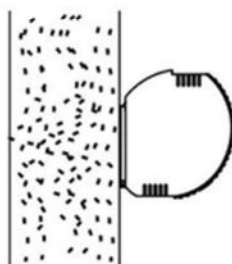

2.6 Don't install the unit in a place where it is splashed by water, exposed to excessive steam, explosive gas or corrosive gas.

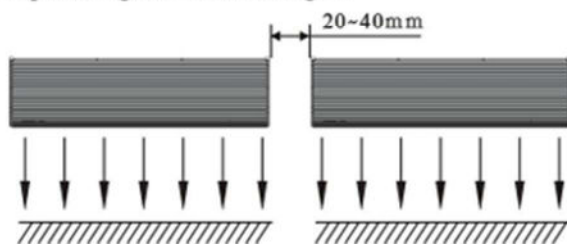

3、INSTALLATION

A、Installing on the concrete wall:

3.1.1 Removed the mounting plate

Unclamping the fixed screws on the back of main body to removed the mounting plate.

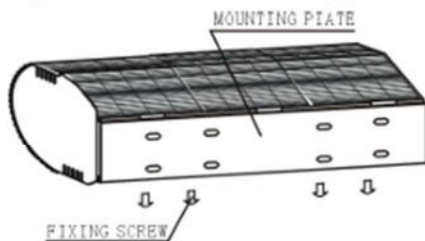

3.1.2 Fix the bolts in the proper position (Decide the position with the mounting plate and pour cement into the bolt holes.)

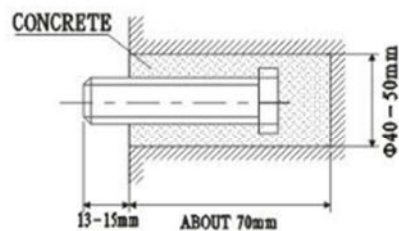

3.1.3 When the cement has freeze, fit the mounting plate (use the washer and nut according to the following)

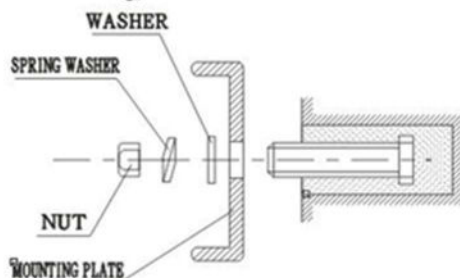

3.1.4 Install the main body

Set the main body onto the upper end of the mounting plate and clamp it as shown.

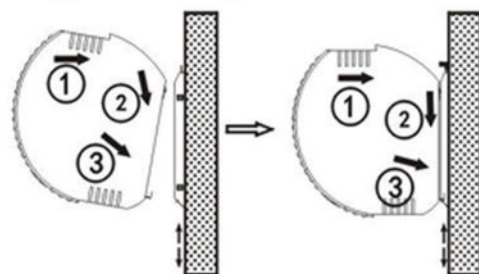

B、Installing on the wooden wall

3.2.1 Fix the mounting plate in the proper positions with tapping screw.

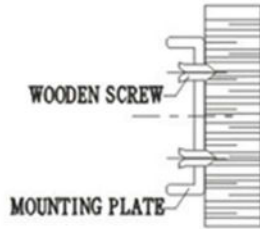

3.2.2 Same as the step 3 of A

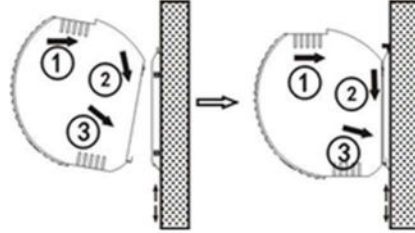

C、Hanging from the ceiling

3.3.1 Remove the mounting plate from main body (Same as step 3.1.1)

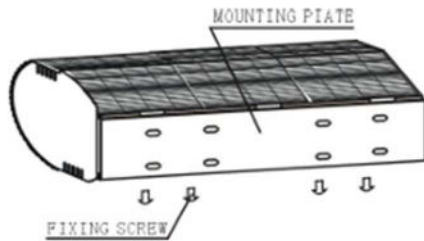

3.3.2 Fixing ceiling brackets as Fig.

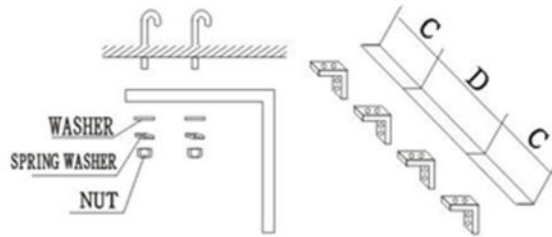

3.3.3 Set the mounting plate on the ceiling brackets and ensure safe & fixing (use the bolts attached to the ceiling brackets as Fig. Using the ceiling brackets to hang from the ceiling, the position of mounting plate can be adjusted in the limit of 100mm.

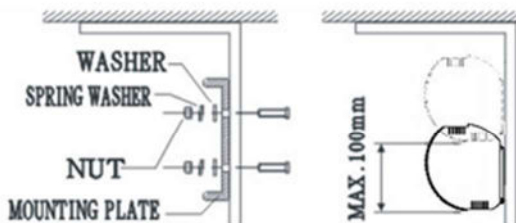

3.3.4 Do the same as step A to install the main body.

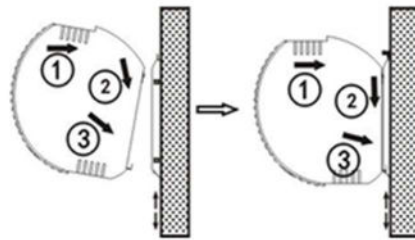

D、For above ceiling

3.4.1 Fix the air curtain as in the procedure for installing on the concrete wall.

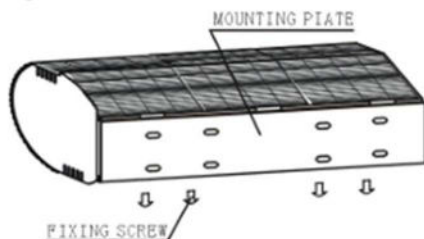

3.4.2 Then pipe as below Fig. Instructs.

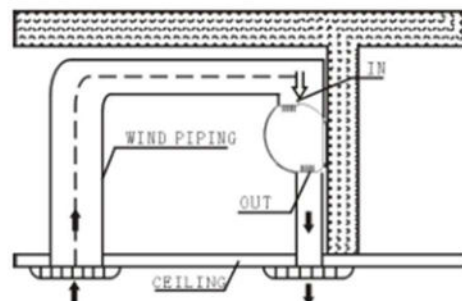

4、 TECHNICAL PARAMETER

MOD EL	Volt (V~)	Freq (Hz)	Max input power (W)		Max air speed (m/s)		Air volume (m ³ /h)		Noise (dB)		Net weight (Kg)	
			H	L	H	L	H	L	H	L		
Premium plus 90cm Premium plus 90cm BLK	220- 240	50	230	200	20	16	1100	900	52	49	13.5	
Premium plus 100cm Premium plus 100cm BLK			250	220			1200	1000	52	49		14
Premium plus 120cm Premium plus 120cm BLK			290	260			1500	1200	53	50		16
Premium plus 150cm Premium plus 150cm BLK			380	350			1900	1500	55	52		20.5
Premium plus 180cm Premium plus 180cm BLK			450	420			2280	1800	57	55		24
Premium plus 200cm Premium plus 200cm BLK			470	440			2520	2100	58	56		27.5

5、 ELECTRIC WORK

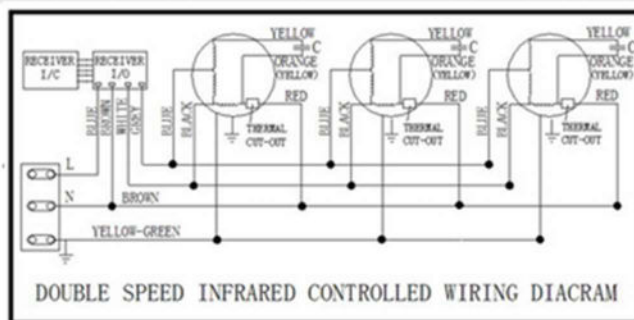

6、 OPERATION

- 6.1 Turn on the power switch
- 6.2 Select the best speed: High[H]、 Low[L]
- 6.3 According to the installation place to adjust the wind direction parts to obtain the best effect.

7、 CAUTIONS

- a)、 Use the unit at the rated voltage and frequency indicated on the nameplate.
- b)、 Disconnect power source before unit operation.
- c)、 Routing maintenance must be done every year.
- d)、 Never use petrol, benzene, thinner or any other such chemical for clearing the unit.
- e)、 Don't allow water or anything enter the motor.
- f)、 When power supply comes from socket, the plug must accord with IEC335-1. When the power cord is connected with charging line directly, all polarity switches that the contact gap is 3mm at least must be installed in the charging line.

ATTENTIONS:

1. These Instructions shall be provided with the appliance so that the appliance can be used safely.
2. The specific instructions related to the safe operation of this appliance shall be collated together in the front section of the user instructions.
3. These instructions shall also be available in an alternative format, e.g. on a website.
4. This appliance can be used by children aged from 8 years and above and persons with reduced physical, sensory or mental capabilities or lack of experience and knowledge if they have been given supervision or instruction concerning use of the appliance in a safe way and understand the hazards involved
5. Children shall not play with the appliance. Cleaning and user maintenance shall not be made by children without supervision.
6. If the supply cord is damaged, it must be replaced by the manufacturer, its service agent or similarly qualified persons in order to avoid a hazard.